

Master Word List

CH words: chair, chimpanzee, chicken, bench

CK words: sock, clock, duck, kick

CR words: crab, crushed can, crayon, crocodile

DGE words: judge, bridge, fridge, badge

FL words: flip flops, flamingo, flag, flower

GR words: grapes, groundhog, groceries, grocery cart

ING words: king, sing, swing, ring

KN words: knight, knit, knob, knot

ND words: sand, diamond, hand, wand

NK words: skunk (or stink), bank, sink, trunk

NT words: tent, ant, elephant, paint

PH words: phone, photographs, pharaoh, photographer

SH words: shoe, brush, fish, ship

SL words: sleep, slip, sloth, sled

SN words: snake, sneaker, snail, snowman

ST words: nest, stamp, stop, stove

TCH words: catch, scratch, match, hatch

TH words: thread, thermometer, tooth, wreath

TR words: tree, trash, train, tractor

WH words: wheel, whistle, whisk, whale

Bonus words: BL: blue, block; FR: French fries, frog

Bonus words: GL: globe, glue; SK: skunk, skateboard

Please note: key letters may be found either at the beginning or the end of the word.

Cut out the pictures of the words that contain the letters CH and paste them into the correct spaces.

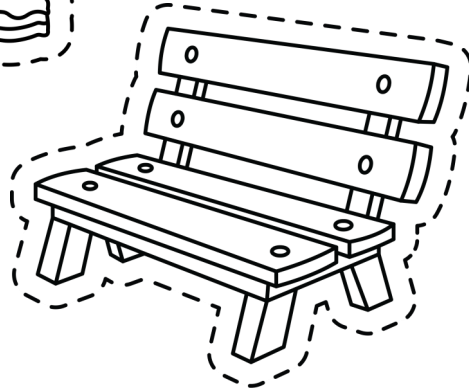
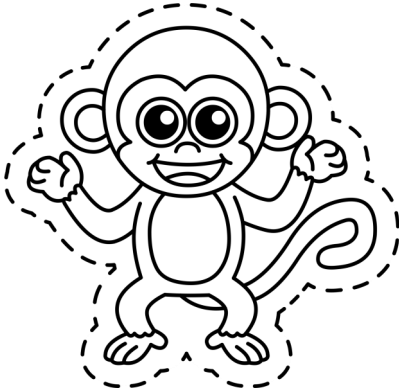
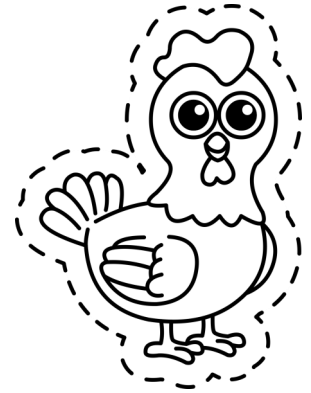
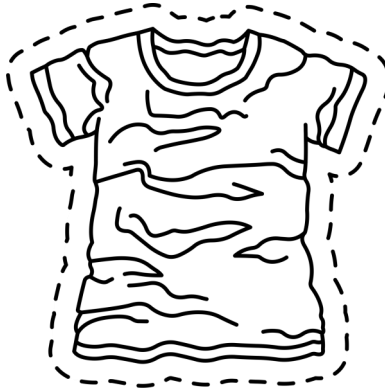
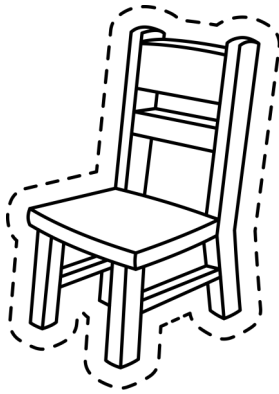

Cut out the pictures of the words that contain the letters CK and paste them into the correct spaces.

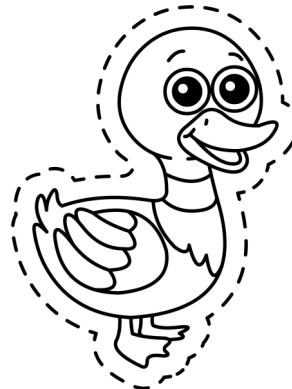
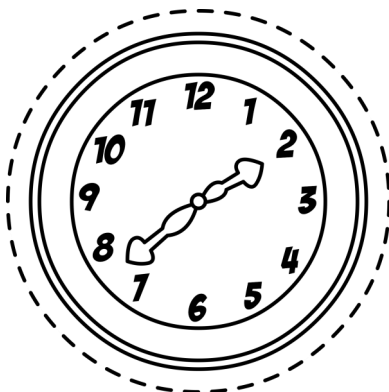
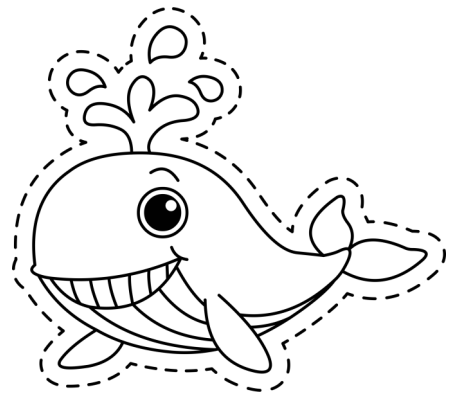
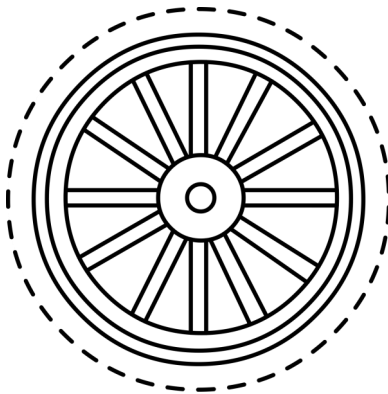
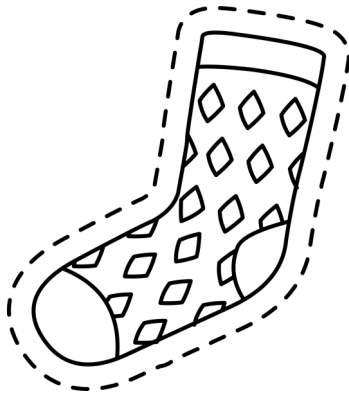

Cut out the pictures of the words that contain the letters CR and paste them into the correct spaces.

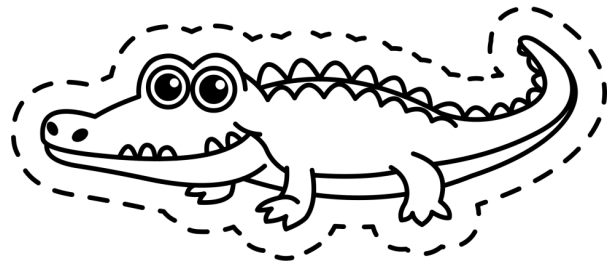
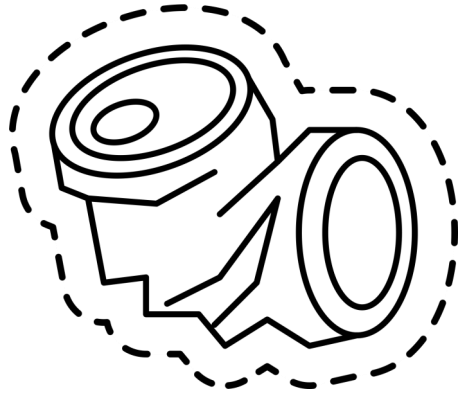
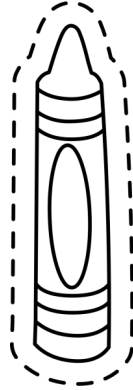
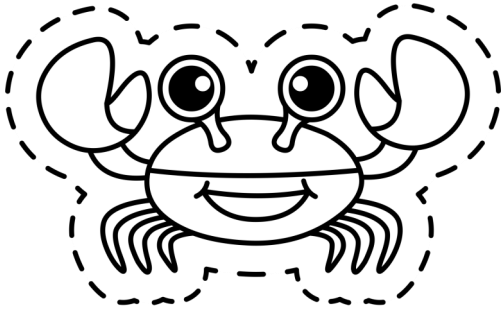

Cut out the pictures of the words that contain the letters DGE and paste them into the correct spaces.

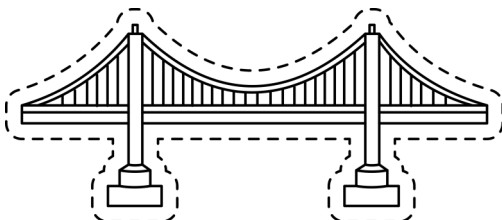
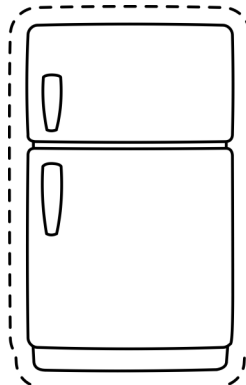
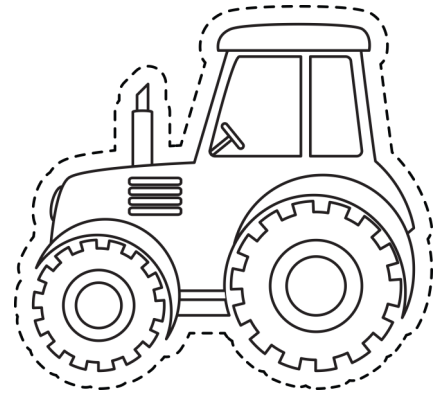
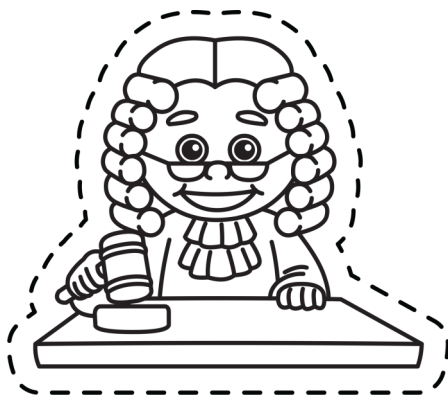

Cut out the pictures of the words that contain the letters FL and paste them into the correct spaces.

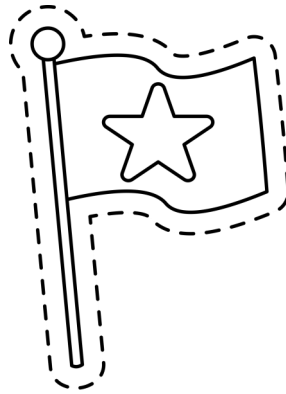
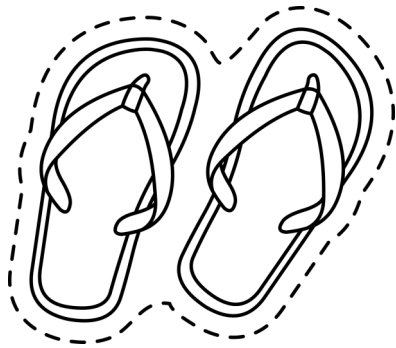
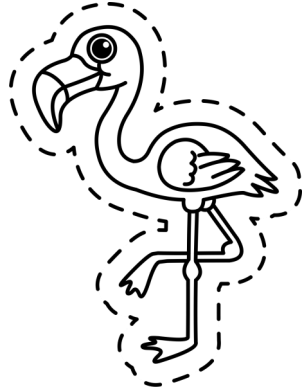
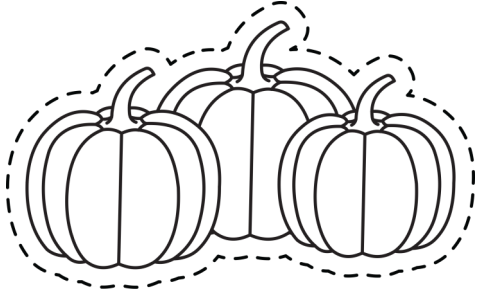

Cut out the pictures of the words that contain the letters GR and paste them into the correct spaces.

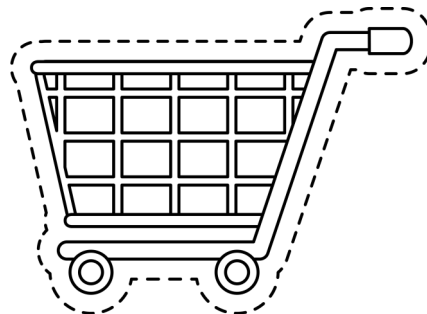
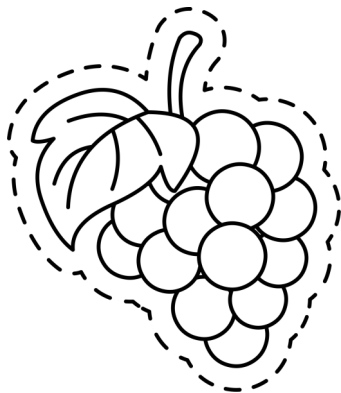
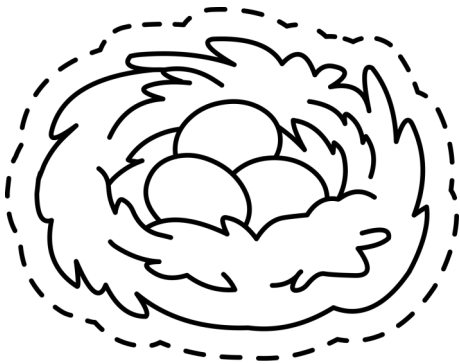

Cut out the pictures of the words that contain the letters ING and paste them into the correct spaces.

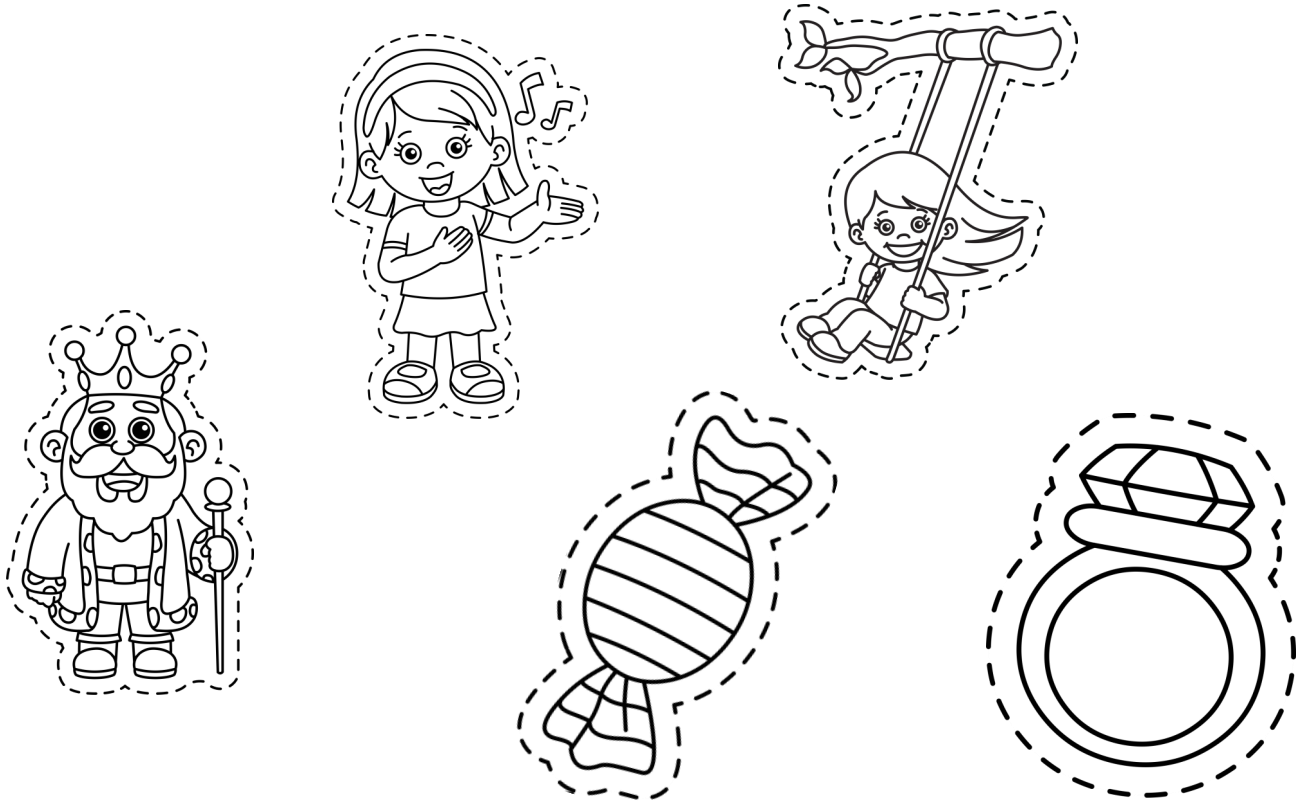

Cut out the pictures of the words that contain the letters KN and paste them into the correct spaces.

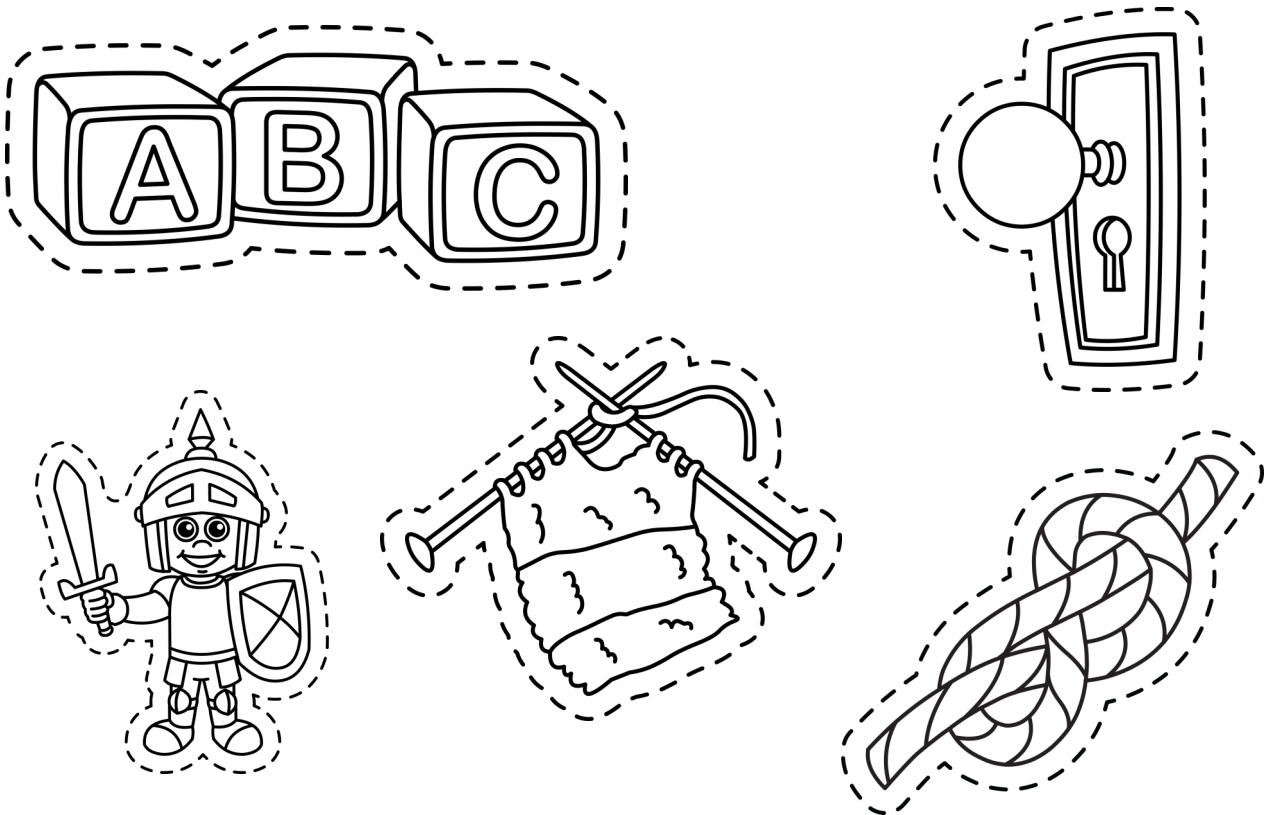

Cut out the pictures of the words that contain the letters ND and paste them into the correct spaces.

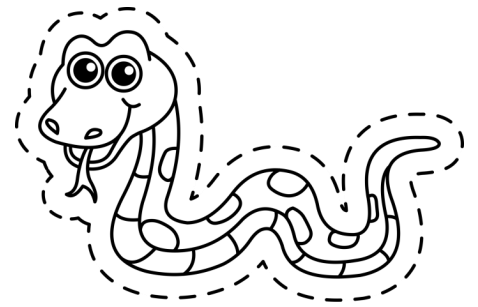
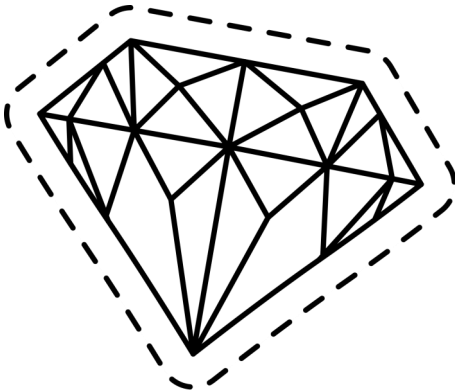
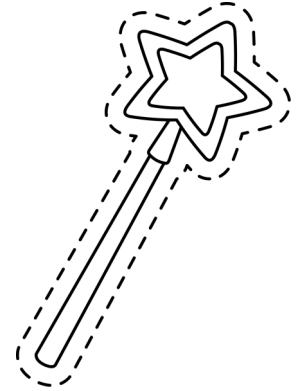
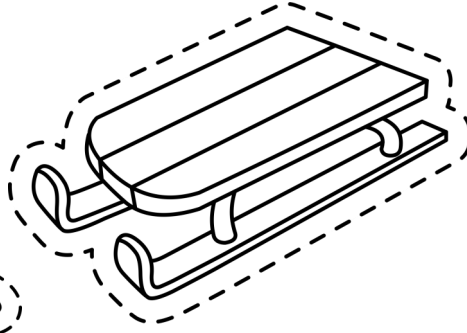
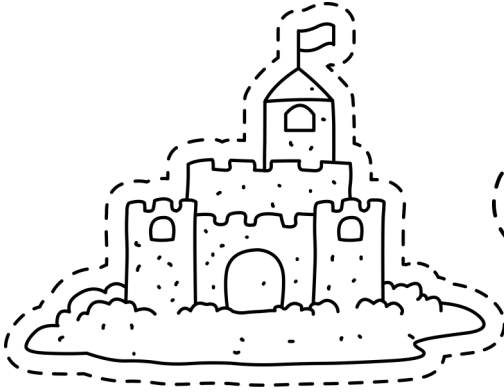

Cut out the pictures of the words that contain the letters NK and paste them into the correct spaces.

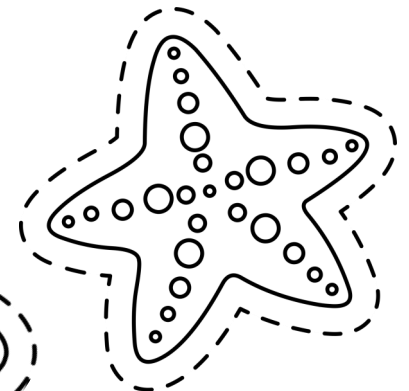
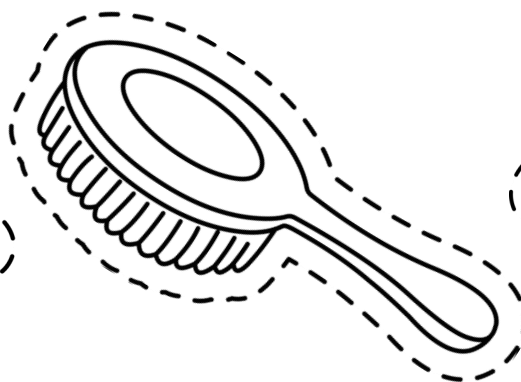
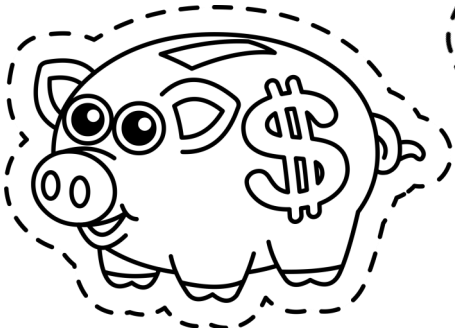
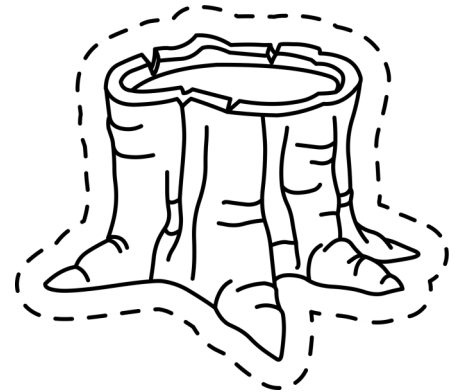
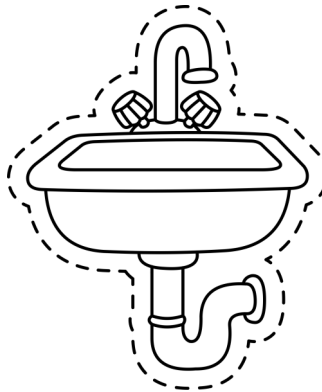

Cut out the pictures of the words that contain the letters NT and paste them into the correct spaces.

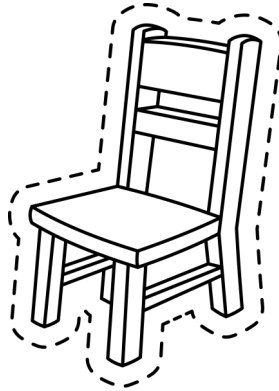
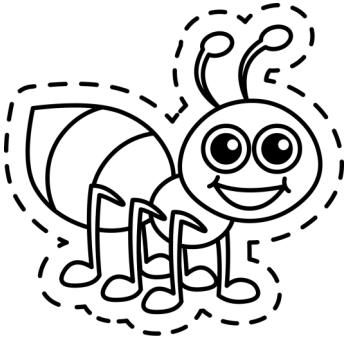
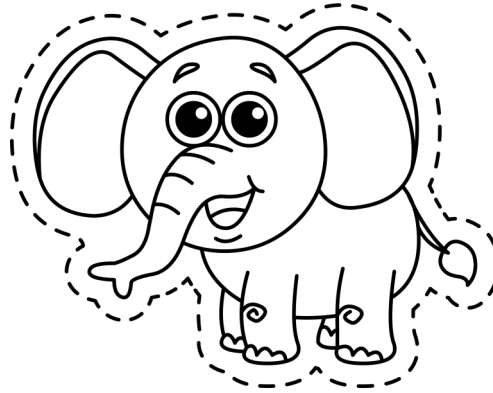
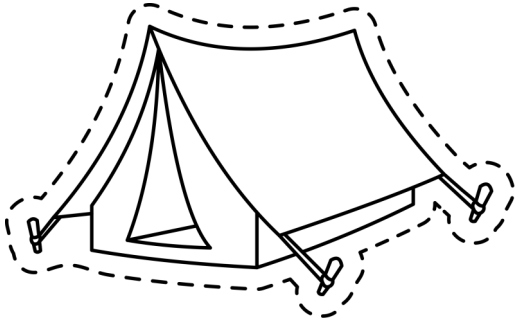

Cut out the pictures of the words that contain the letters PH and paste them into the correct spaces.

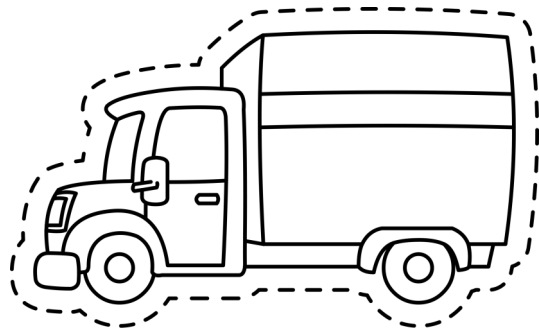
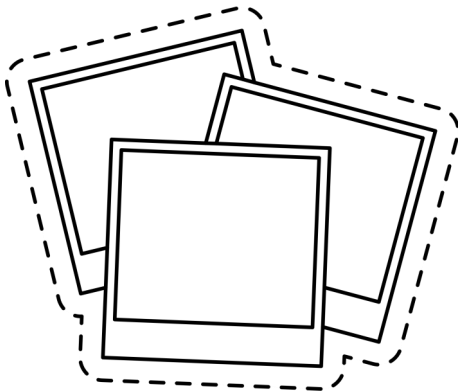

Cut out the pictures of the words that contain the letters SH and paste them into the correct spaces.

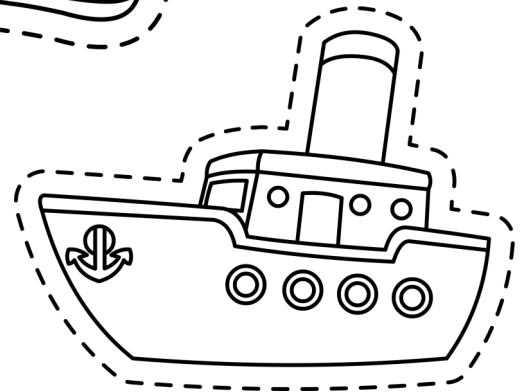
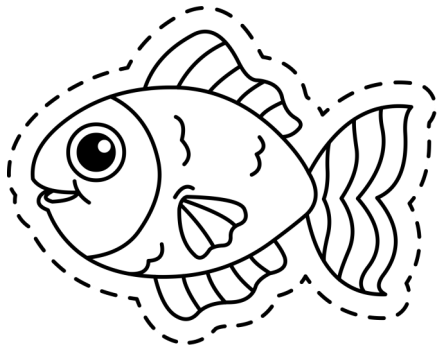
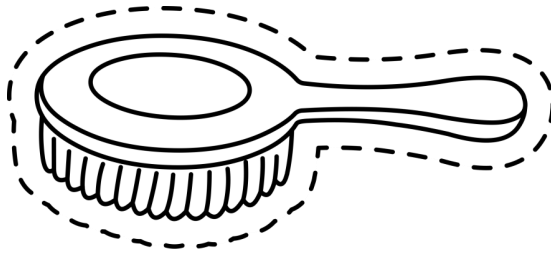
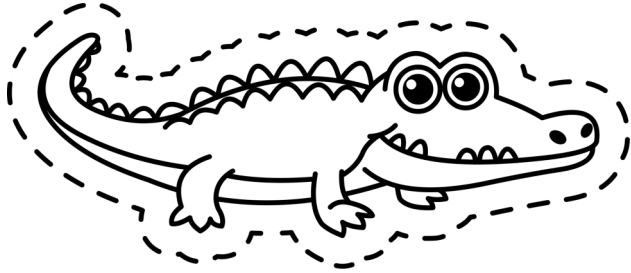

Cut out the pictures of the words that contain the letters SL and paste them into the correct spaces.

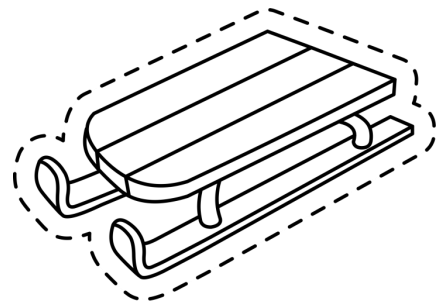
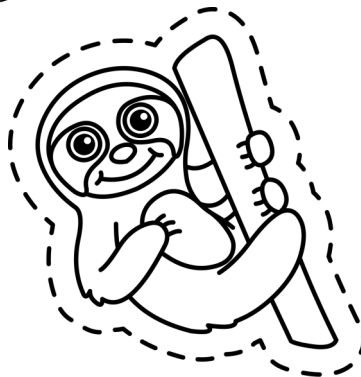

Cut out the pictures of the words that contain the letters SN and paste them into the correct spaces.

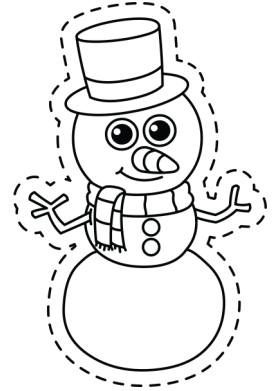
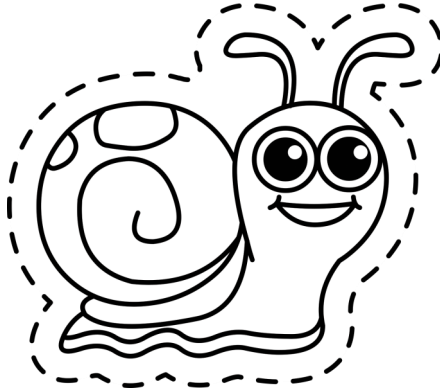
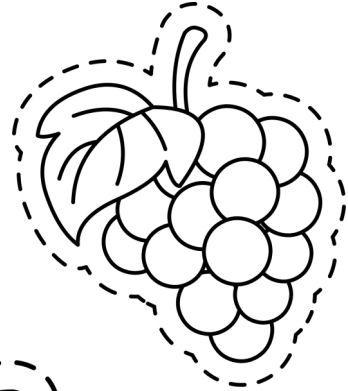
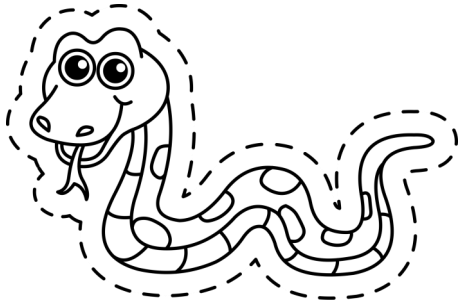

Cut out the pictures of the words that contain the letters ST and paste them into the correct spaces.

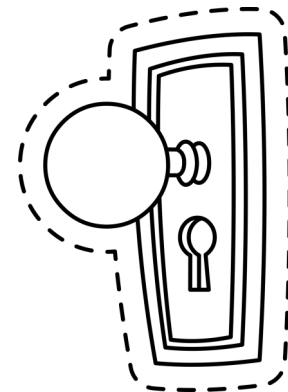
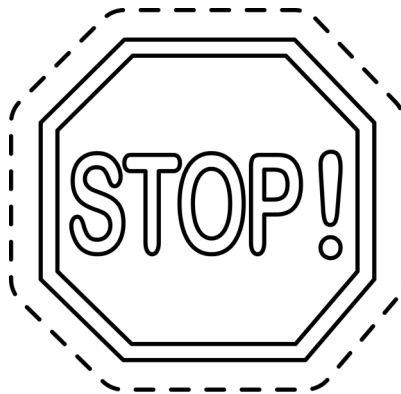
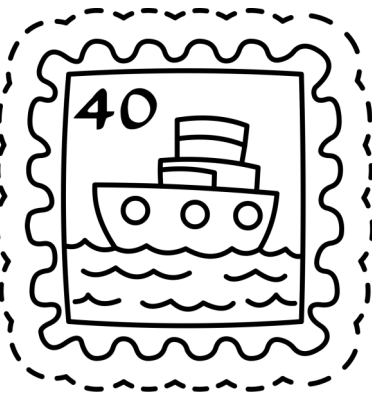
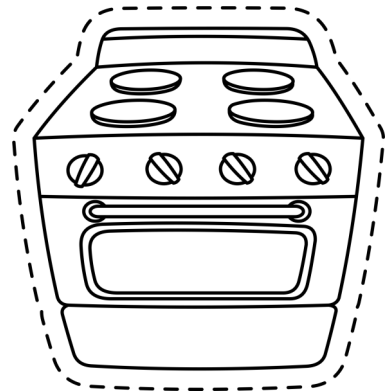
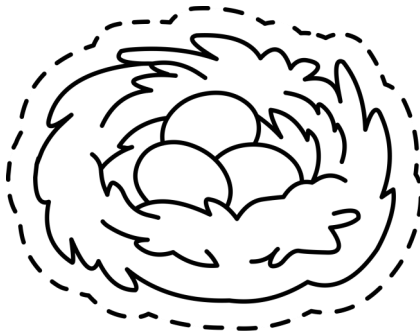

Cut out the pictures of the words that contain the letters TCH and paste them into the correct spaces.

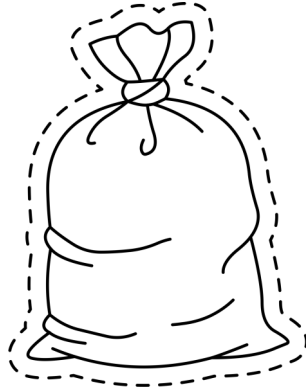
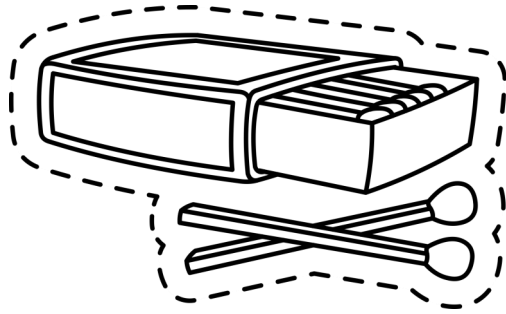

Cut out the pictures of the words that contain the letters TH and paste them into the correct spaces.

A line drawing of a spool of thread with a needle and thread passing through it. The entire scene is enclosed in a dashed-line border for cutting.

A line drawing of a single tooth. The entire scene is enclosed in a dashed-line border for cutting.

A line drawing of a jar of flour with the word "FLOUR" written on the label. The entire scene is enclosed in a dashed-line border for cutting.

A line drawing of a thermometer. The entire scene is enclosed in a dashed-line border for cutting.

A line drawing of a human hand, palm facing forward. The entire scene is enclosed in a dashed-line border for cutting.

A line drawing of a Christmas wreath decorated with a bow and berries. The entire scene is enclosed in a dashed-line border for cutting.

WriteBonnieRose.com

10

Cut out the pictures of the words that contain the letters TR and paste them into the correct spaces.

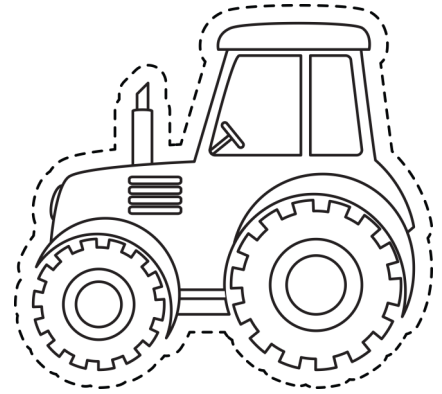
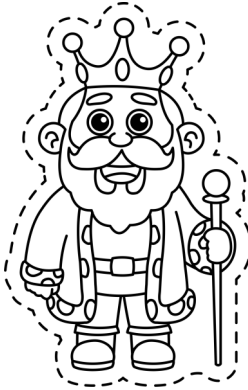
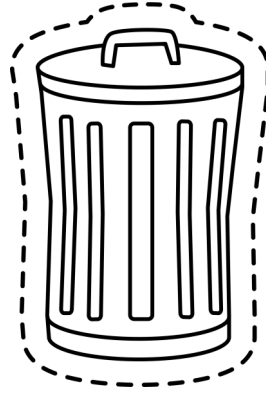
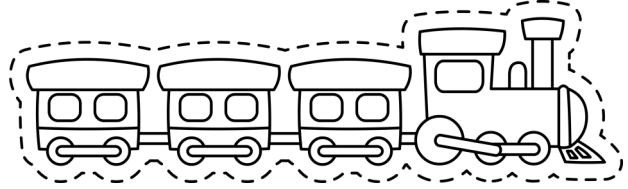
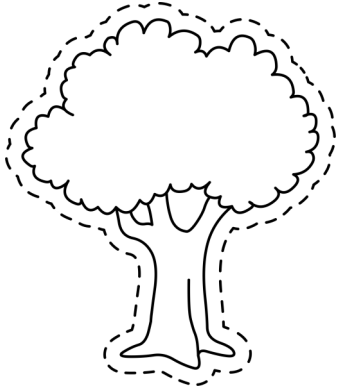

Cut out the pictures of the words that contain the letters WH and paste them into the correct spaces.

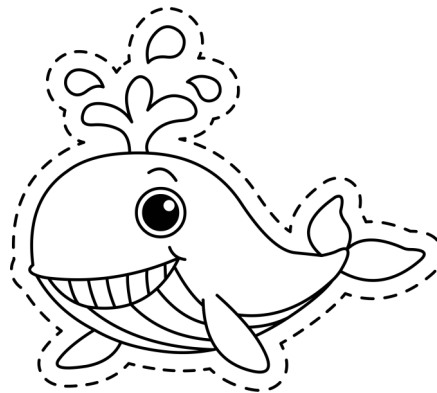
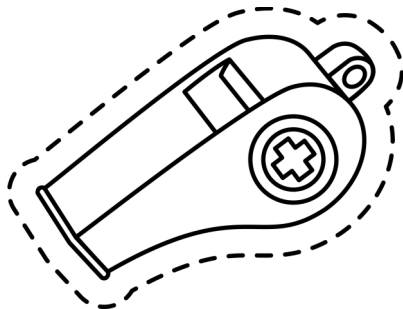
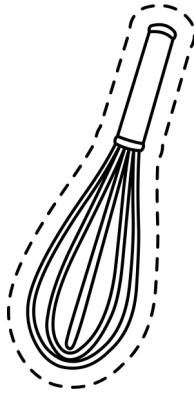
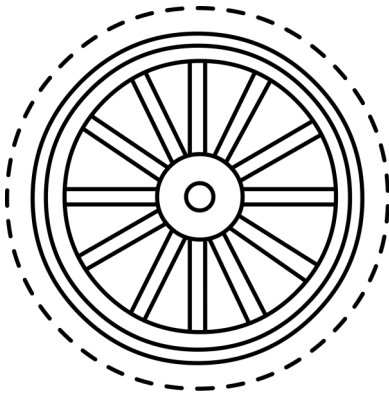

BONUS: Cut out the TWO pictures of the words that contain the letters BL and paste them into the correct spaces; cut out the TWO pictures of the words that contain the letters FR and paste them into the correct spaces.

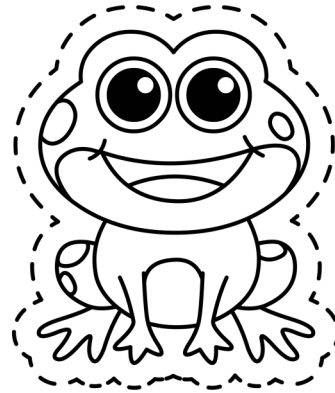
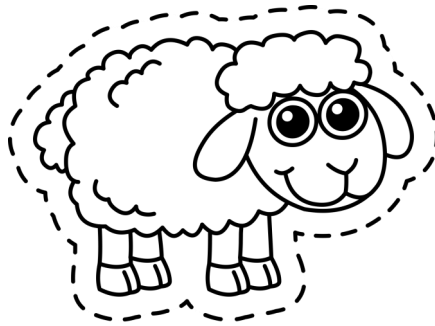
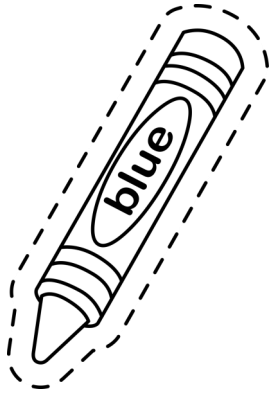
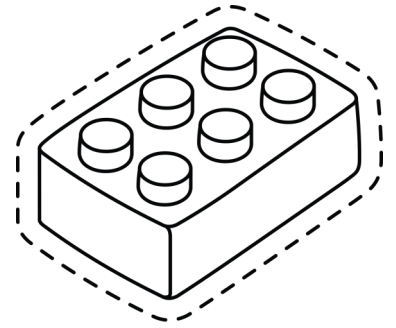
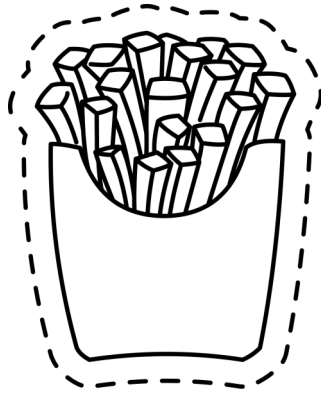

BONUS: Cut out the TWO pictures of the words that contain the letters GL and paste them into the correct spaces; cut out the TWO pictures of the words that contain the letters SK and paste them into the correct spaces.

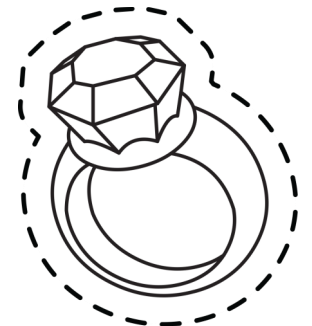
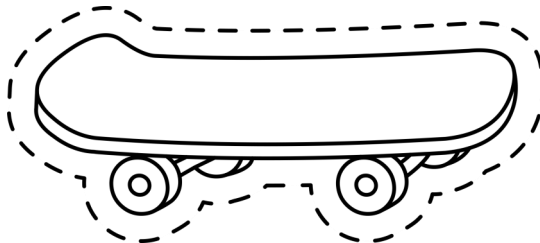
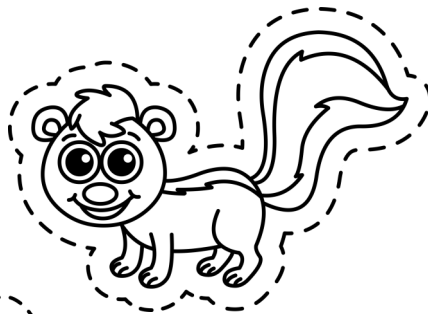





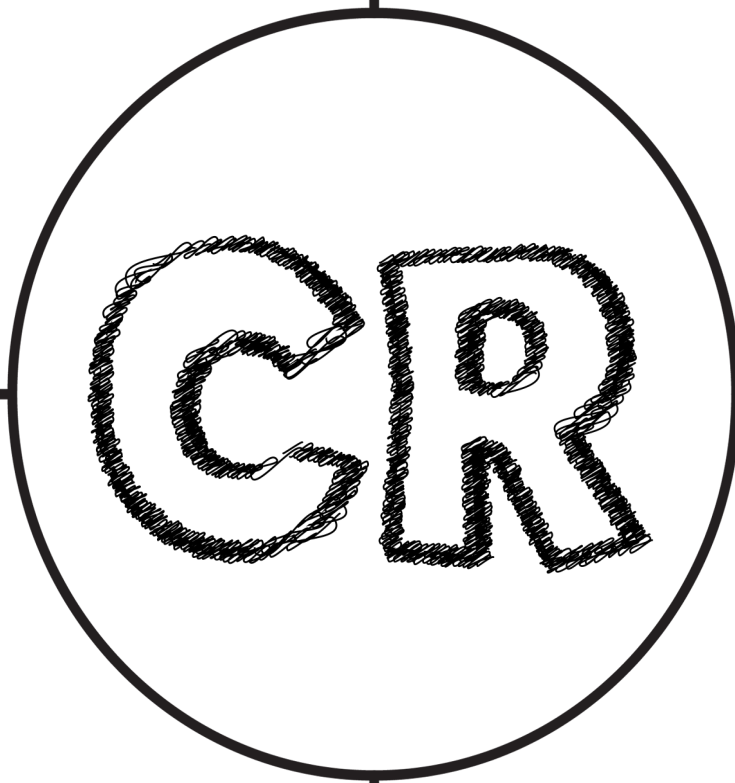

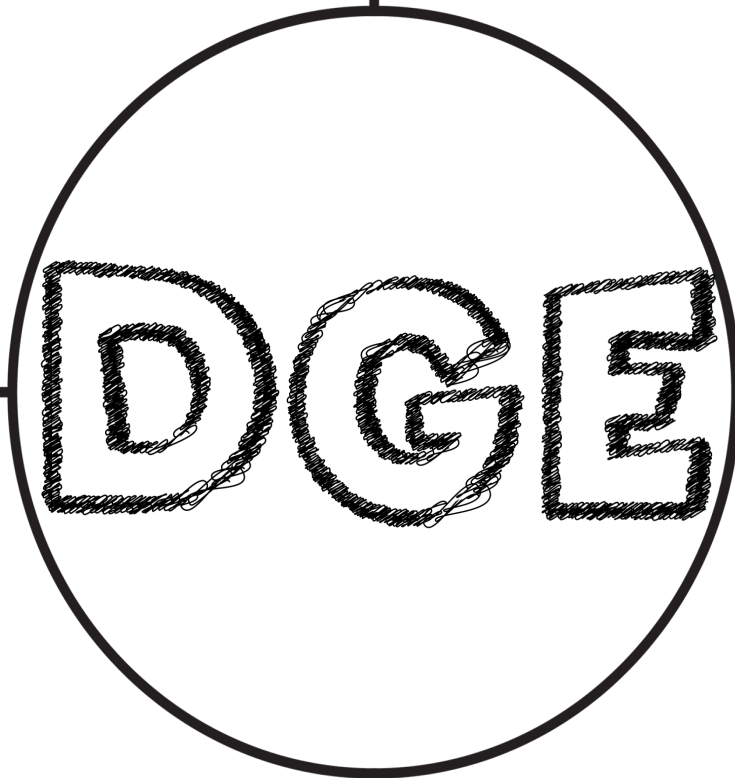

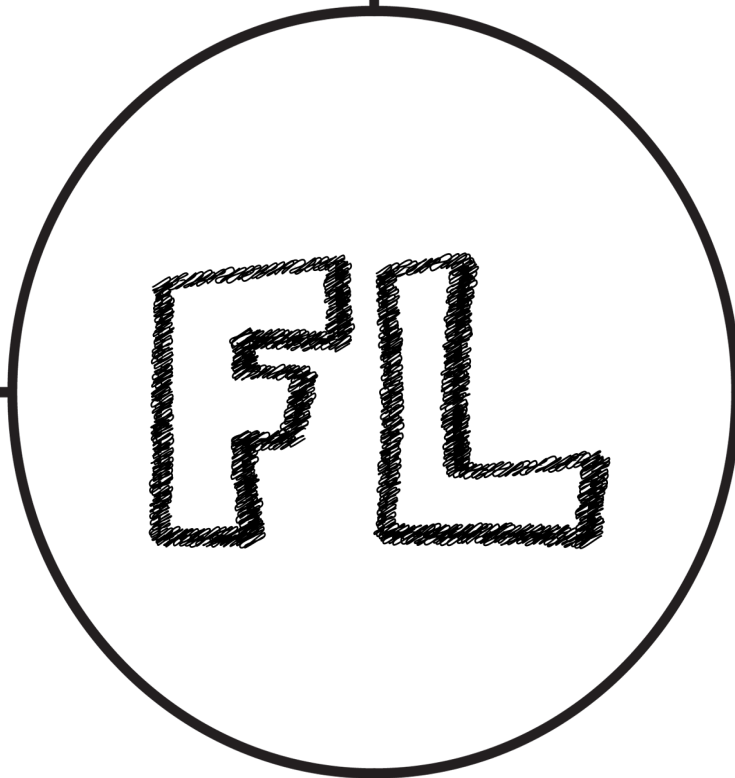





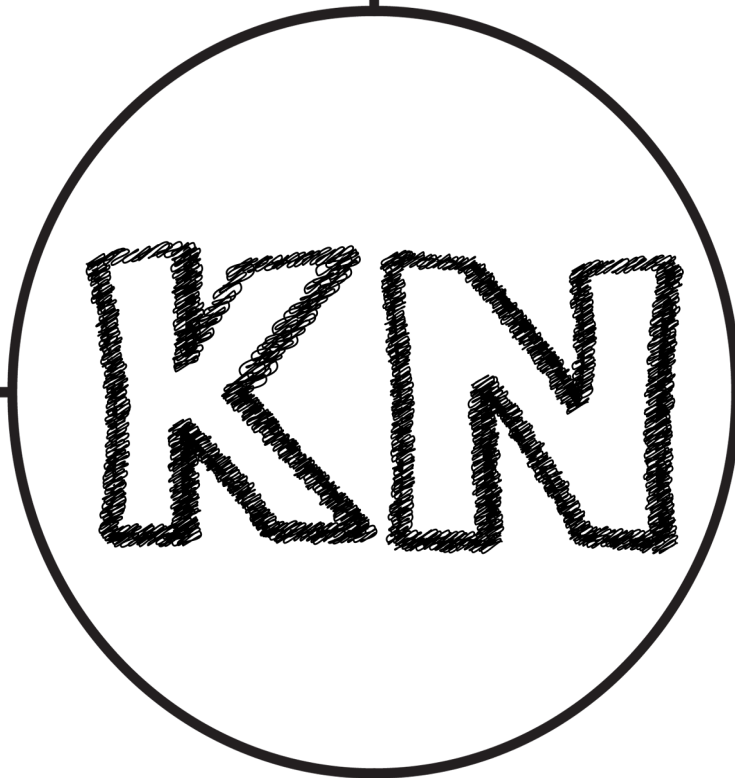







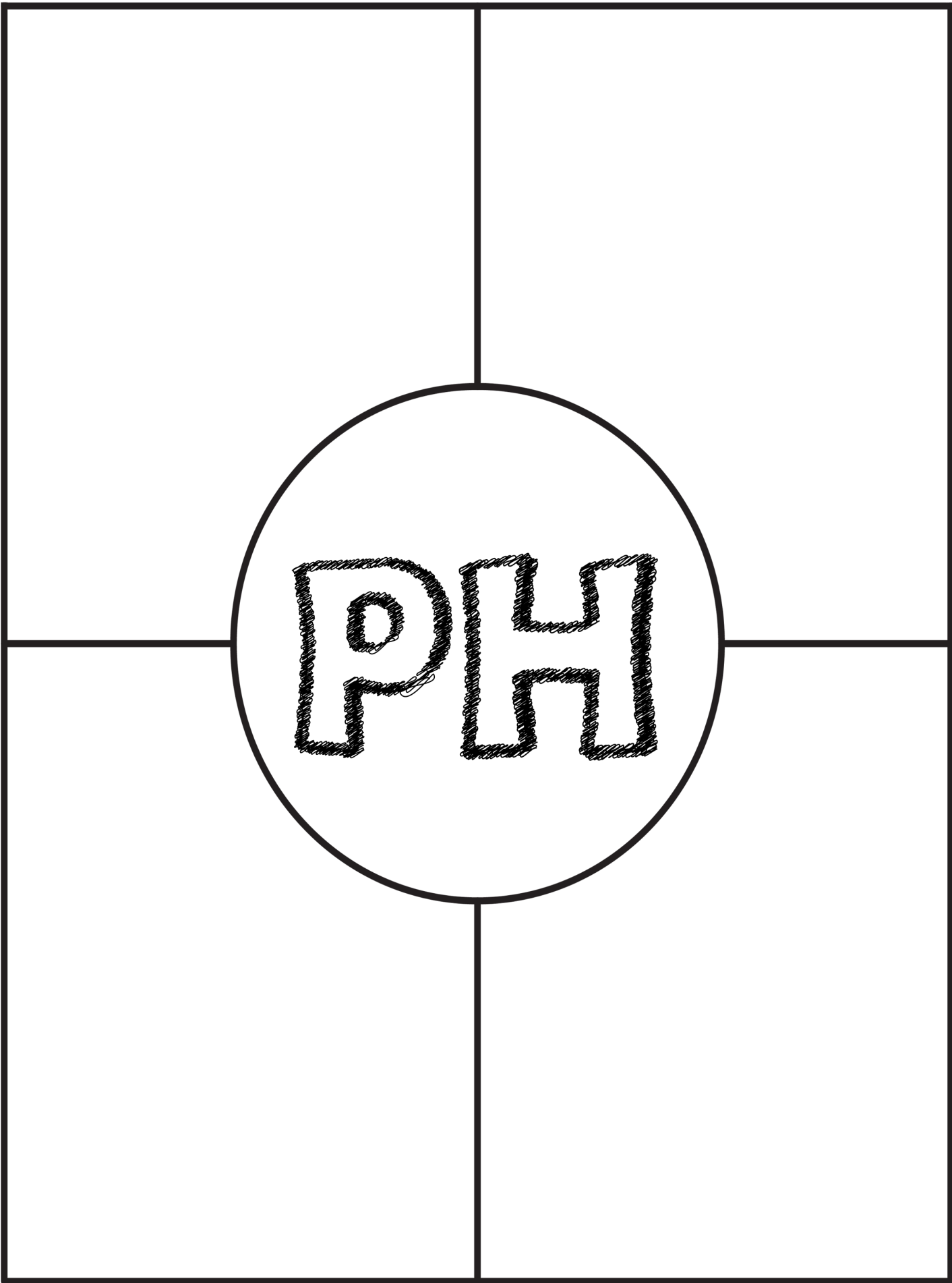
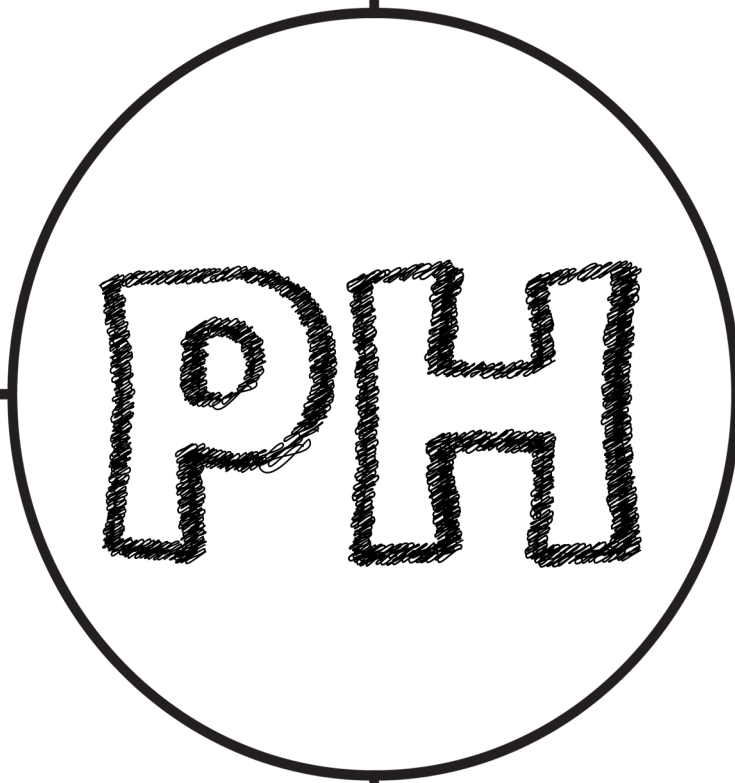







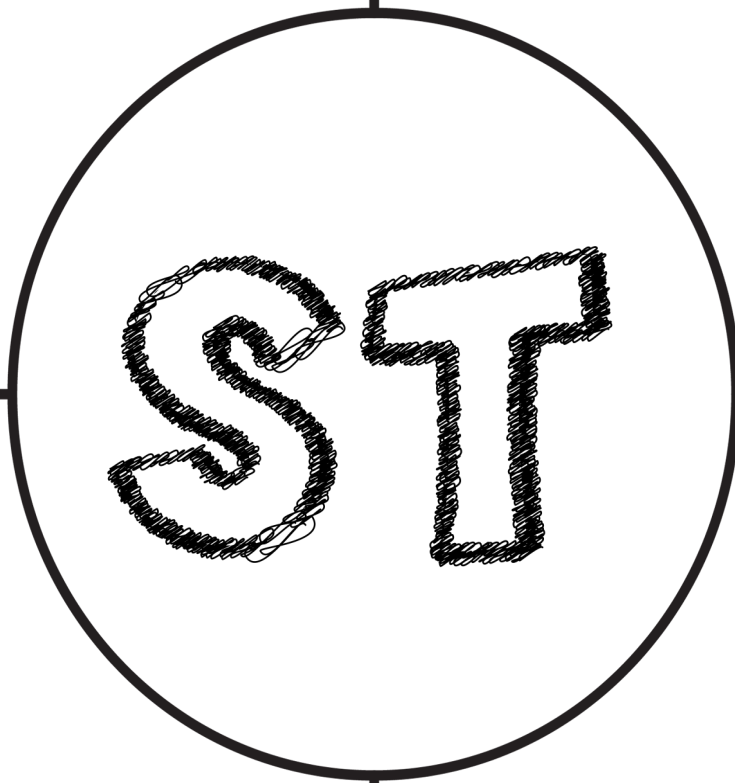

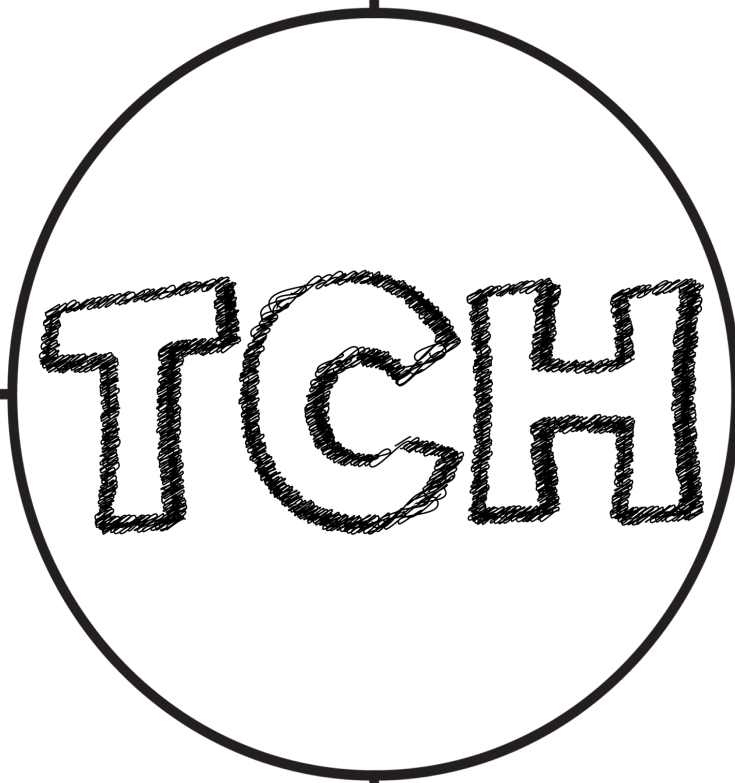



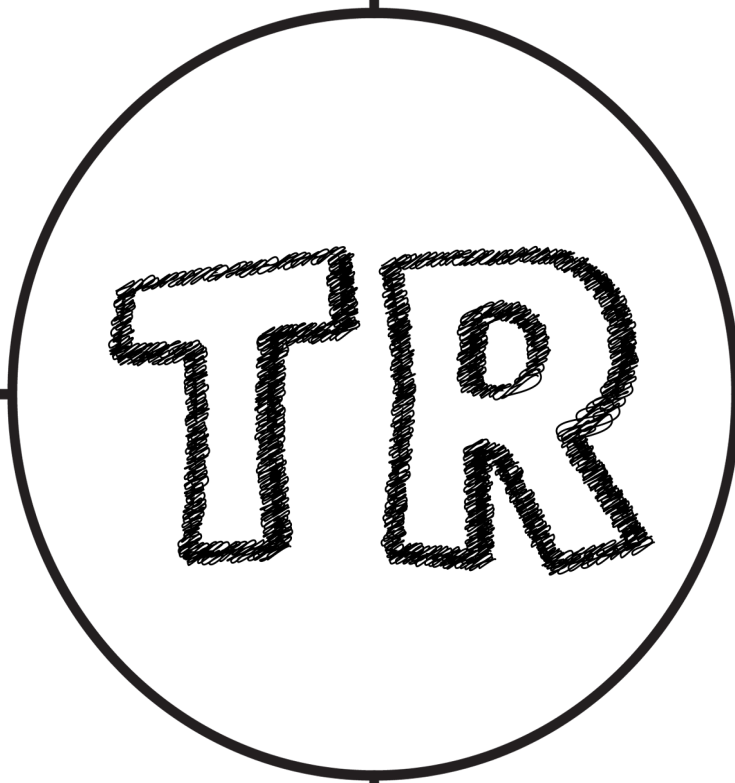



BL

FR

GL

SK

Copyright © 2019 by WriteBonnieRose, LLC



Select graphics used courtesy of [Zip-a-Dee-Doo-Dah Designs](#) and [Hidesy's Clipart](#).

Select graphics used courtesy of and licensed by Dancing Crayon Designs © www.DancingCrayon.com.

All Rights Reserved. This book may not be reproduced or transmitted by any means, including graphic, electronic, or mechanical, without the express written consent of the author except in the case of brief quotations embodied in critical articles and reviews and those uses expressly described in the following Terms of Use. You are welcome to link back to the author's website, <http://writebonnierose.com>, but may not link directly to the PDF file. You may not alter this work, sell or distribute it in any way, host this file on your own website, or upload it to a shared website.

Terms of Use: For use by a family, this unit can be printed and copied as many times as needed. Classroom teachers may reproduce one copy for each student in his or her class. Members of co-ops or workshops may reproduce one copy for up to fifteen children. This material cannot be resold or used in any way for commercial purposes. Please contact the publisher with any questions.